

# GLM-RC (Basisrahmen)

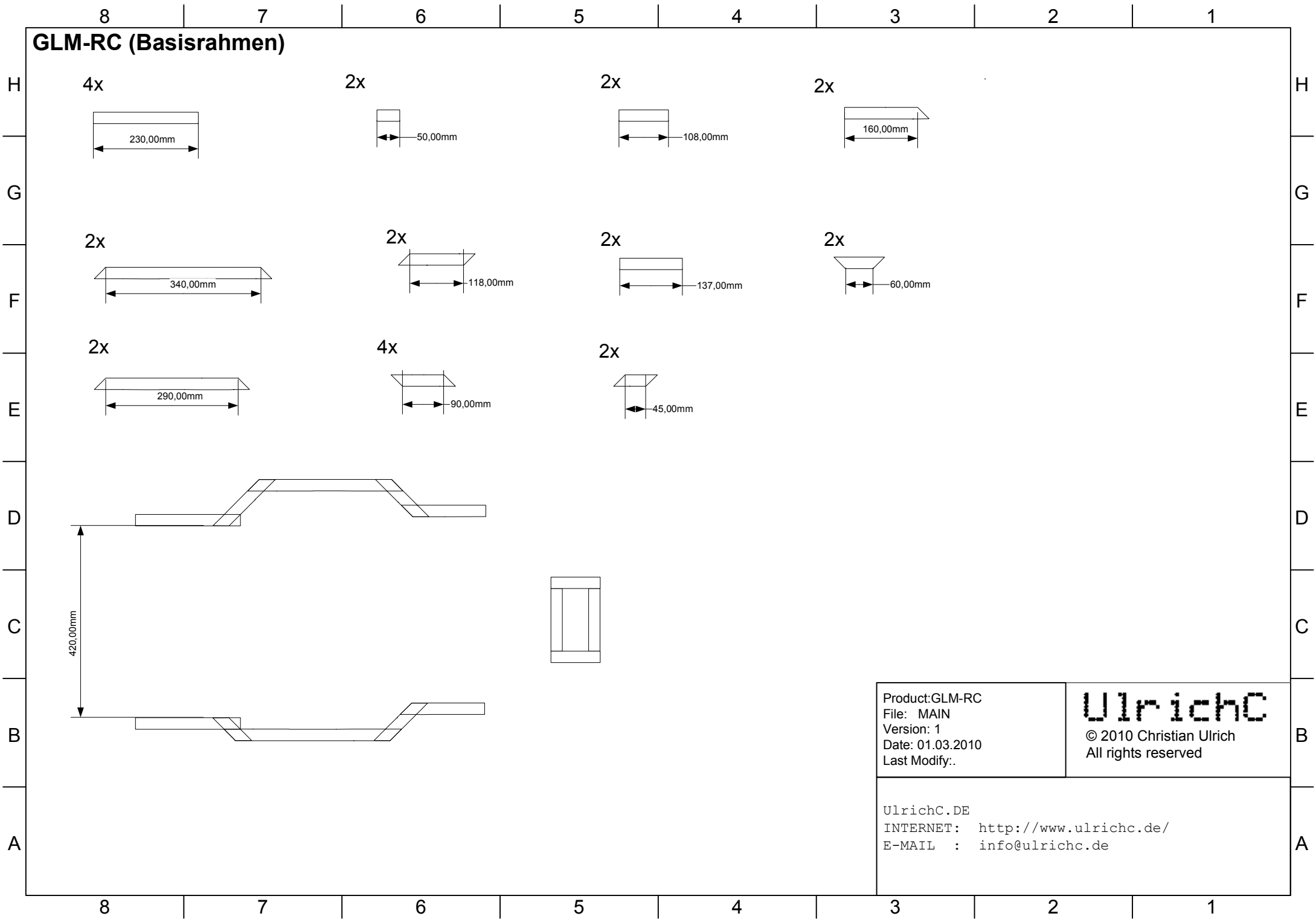

Product: GLM-RC File: MAIN Version: 1 Date: 01.03.2010 Last Modify:	<b>UlrichC</b> © 2010 Christian Ulrich All rights reserved
---	--

UlrichC.DE INTERNET: <a href="http://www.ulrichc.de/">http://www.ulrichc.de/</a> E-MAIL : <a href="mailto:info@ulrichc.de">info@ulrichc.de</a>
--

# GLM-RC (Front-Basisrahmen)

H  
G  
F  
E  
D  
C  
B  
A

H  
G  
F  
E  
D  
C  
B  
A

8 7 6 5 4 3 2 1

8 7 6 5 4 3 2 1

2x

2x

2x

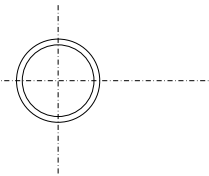
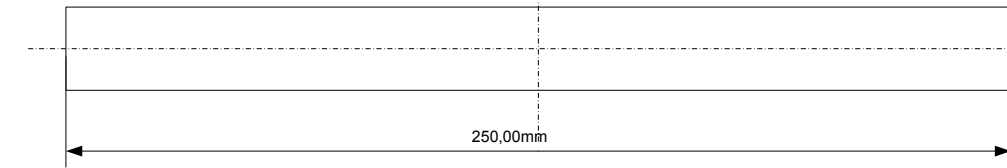
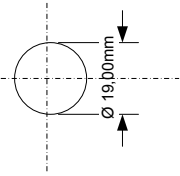
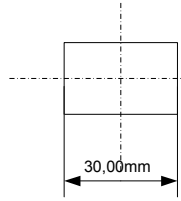
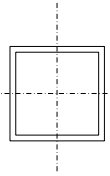
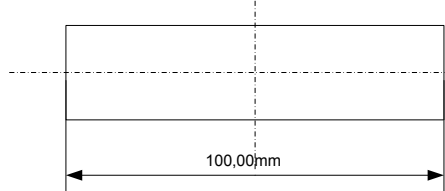

Product:GLM-RC  
File: MAIN  
Version: 1  
Date: 01.03.2010  
Last Modify:.

**UlrichC**  
© 2010 Christian Ulrich  
All rights reserved

UlrichC.DE  
INTERNET: <http://www.ulrichc.de/>  
E-MAIL : [info@ulrichc.de](mailto:info@ulrichc.de)

GLM-RC

Basisrahmen

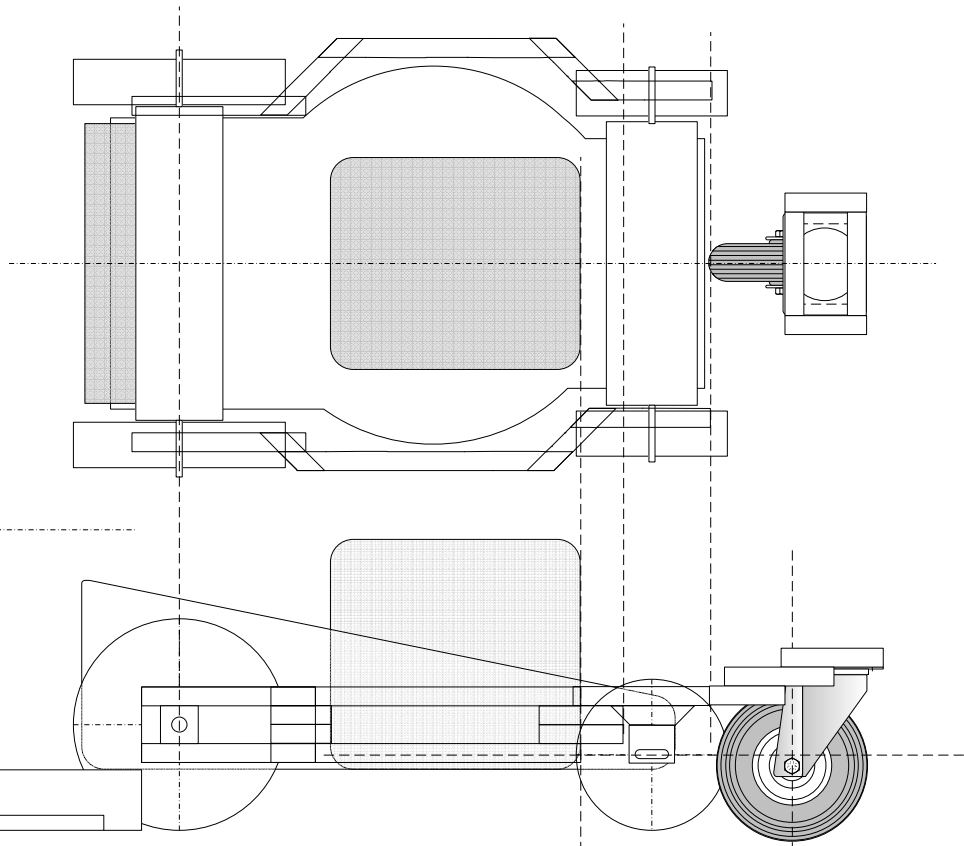

8 cm – höchste Schnitteinstellung

2 cm – niedrigste Schnitteinstellung

Product:GLM-RC  
File: MAIN  
Version: 1  
Date: 01.03.2010  
Last Modify:.

**UlrichC**

© 2010 Christian Ulrich  
All rights reserved

UlrichC.DE  
INTERNET: <http://www.ulrichc.de/>  
E-MAIL : [info@ulrichc.de](mailto:info@ulrichc.de)

# GLM-RC Frontlager

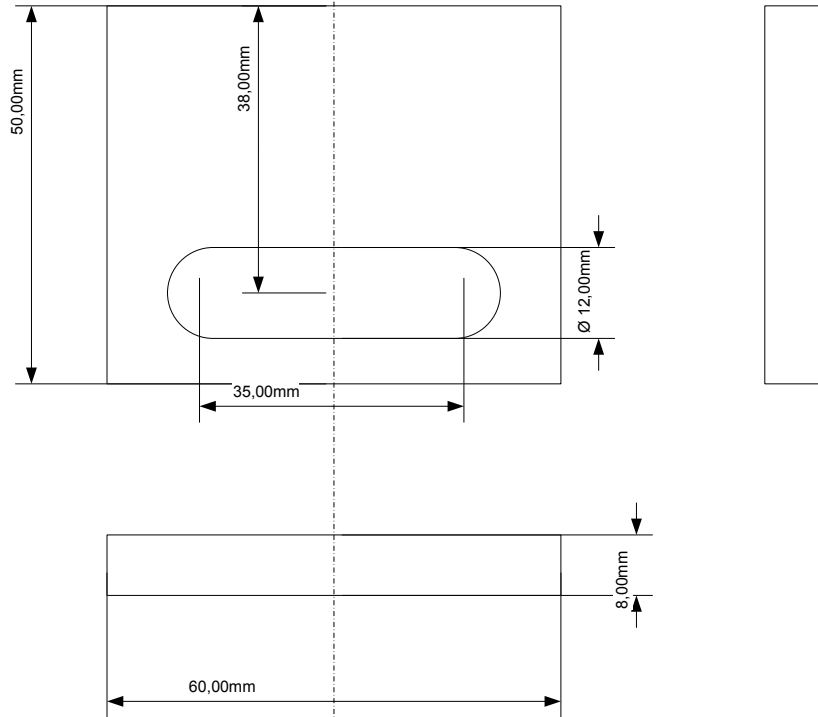

Product:GLM-RC  
File: MAIN  
Version: 1  
Date: 01.03.2010  
Last Modify:.

**UlrichC**  
© 2010 Christian Ulrich  
All rights reserved

UlrichC.DE  
INTERNET: <http://www.ulrichc.de/>  
E-MAIL : [info@ulrichc.de](mailto:info@ulrichc.de)